

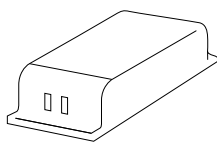

DIMENSION

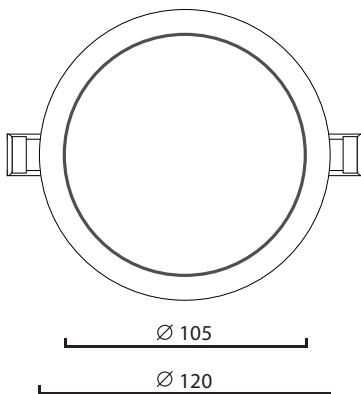

PRODUCT

Name	SCP LED Panel light
Reference	EI-SCP-6W-R
Body color	White
Material	Aluminum
Category	Recessed

LIGHTING INFORMATION

Light source	LED
Gross luminous flux	372Lm
Power	6W
Colour temperature CCT	3000 / 4000/ 6500 K
Colour Rendering Index	CRI = 80
Light beam angle	120°
Number of LEDs	30
Chip Type	SMD2835
Dimming	Non Dimmable
Median useful Life	20,000 hours

OTHER DATA

Light Guide Panel (LGP)	Polystyrene (PS)
Ingress Protection	IP20
Dimension (mm)	Ø 120mm
Cut-Size (mm)	Ø 105mm

DRIVER OPTIONS

ON / OFF	
Class II	
Frequency (Hz)	50/60 Hz
Power Factor	0.5
Mains voltage	AC 85-265V
Ingress Protection	IP20

PHOTOMETRIC DETAILS

Luminous Intensity Distribution Curve

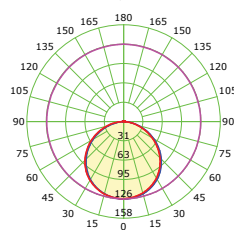

The Average Illuminance Effective Figure

